

# PAR 56 FOUNTAIN RGBW POWER

OC



## Cod. 6013383594

LAMP WITH SUPPORT and 4m CABLE

LED lamp for fountains with variable RGBW colour, ideal for large installations. PLC control. Available with various lenses to illuminate pools or different water jets. With the orientable bracket installation in any position is possible.

### Technical data:

Power supply	12 V AC
Current	6.05 A
Maximum real power consumption	69 W
Maximum apparent power consumption	87 VA
Electrical insulation class	III
Connections	4 m NEOPRENE CABLE 2X4
Maximum cable length	22 m
Beam angle	15°
Number of LEDs	36
LED color	RGBW
Total luminous flux	2970 lumen
White luminous flux	1260 lumen
Red luminous flux	504 lumen
Green luminous flux	864 lumen
Blue luminous flux	216 lumen
Body made of	AISI316L STEEL AND GLASS
Weight	1.5 kg
Ingress Protection rating	IP68
Working conditions	EXCLUSIVELY IN WATER
Maximum ambient temperature	(water) 40 °C
Control signal	POWER LINE COMUNICATION
Nr of programmed colors	13
Nr of programmed sequences	10

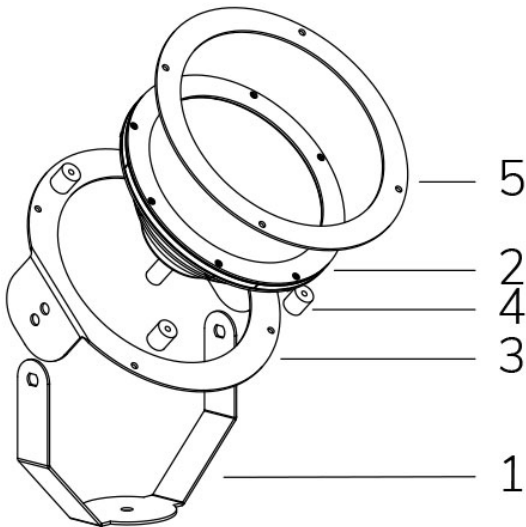

- 1 MOUNTING BRACKET
- 2 LAMP
- 3 LAMP SUPPORT
- 4 SPACERS
- 5 SUPPORT RING

04/06/20 - All specifications included in this document, in the interest of continuous product improvement and to correct any error, can be changed without notice.

# PAR 56 FOUNTAIN RGBW POWER

OC

**Cod. 6013383594**

LAMP WITH SUPPORT and 4m CABLE

LED lamp for fountains with variable RGBW colour, ideal for large installations. PLC control. Available with various lenses to illuminate pools or different water jets. With the orientable bracket installation in any position is possible.

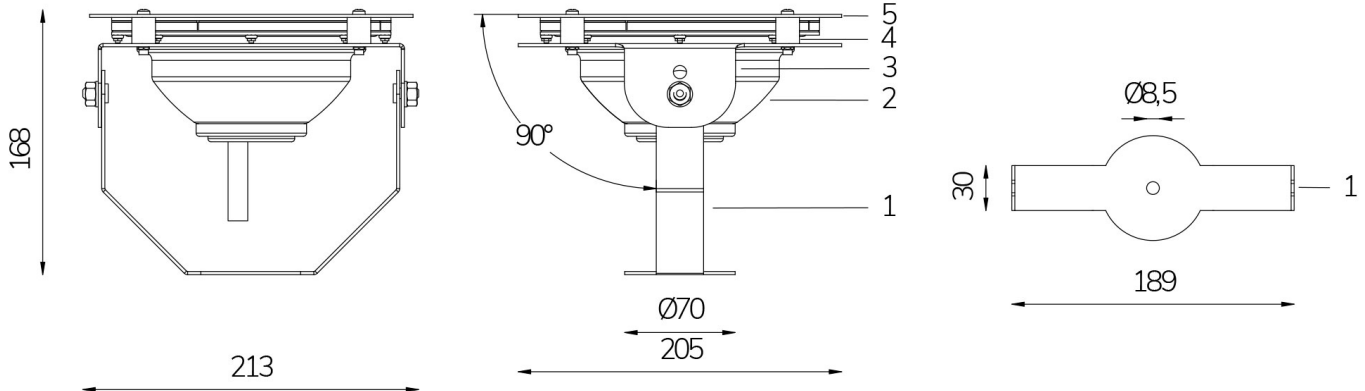

04/06/20 - All specifications included in this document, in the interest of continuous product improvement and to correct any error, can be changed without notice.